

AU003 Ultrasonische taster



Image not found.

126,63 €

Offline prijs
134,00 €-

Incl. 5,5% online korting bij een online-bestelling

Overzicht

- Ultrasonische sensor met RVS-behuizing met M18-schroefdraad.
- Maakcontact/verbreekcontact programmeerbaar
- Instelbaar via leiding-teach
- Herkent niveaus en optisch moeilijke objecten (contrastrijk, reflecterend, transparant, donker, enz.)
- Slijtagevrije en contactloze meting, zelfs in nevel en stof

www.autosen.com/AU003

Directe link naar het artikel op autosen.com

Dagelijks toegepast – deugdelijkheid miljoenen malen bewezen. Autosen-producten worden vervaardigd volgens de hoogste kwaliteitsnormen op het gebied van robuustheid, duurzaamheid en betrouwbaarheid. We bieden u 5 jaar garantie – met geld-terug-garantie!

Maattekening

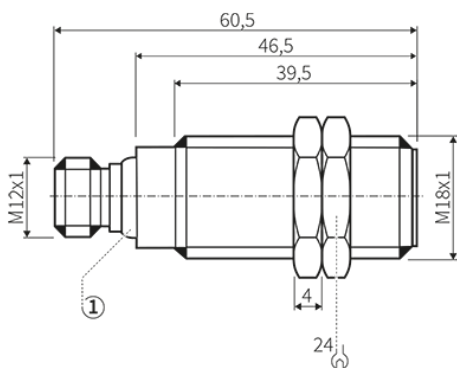

Geluidskegel

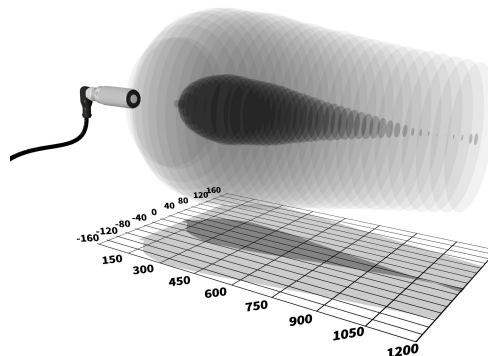

Maattekening legenda

1: LED

Bestel online bij
Telefonische bestelling
Bestelling per fax

www.autosen.com
+49 (0) 201/749 189 21
+49 (0) 201/749 189 22

autosen gmbh • Annastraße 41 • 45130 Essen
www.autosen.com • info@autosen.com
 We behouden ons het recht voor om technische wijzigingen aan te brengen zonder voorafgaande kennisgeving. - 5-4-2025



Aansluitings- & penindeling

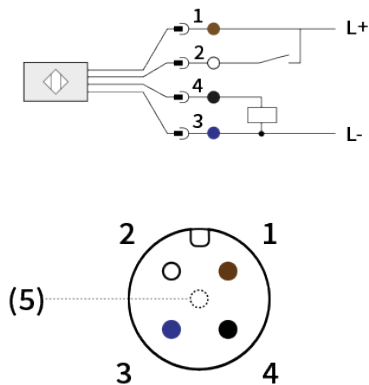

Aansluitings- & penindeling legenda

Pin 2 = Teach

Algemene informatie

Sensortype	Ultraschallsensor
Schakelfrequentie	5Hz
Schakelafstand	80 ... 1200 mm

Uitgangen / ingangen

Schakeluitgang	Schließer / Öffner programmierbar
IO-Link	Nein

Elektrische gegevens

Bedrijfsspanning	10 ... 30 V DC supply class 2 cULus
Spanningstype	Gleichspannung (DC)
Elektrische uitvoering	PNP
Stroomvoerend vermogen max.	100mA
Spanningsval max.	2,2V
Stroomopname max.	35mA
Beschermingsklasse	III
Kortsluitbeveiliging	Ja
Overbelastingsbestendig	Ja
Beveiliging tegen verkeerd aansluiten van polen	Ja
Inschakelvertragingstijd	0,1 s

Bestel online bij
Telefonische bestelling
Bestelling per fax

www.autosen.com
+49 (0) 201/749 189 21
+49 (0) 201/749 189 22

autosen gmbh • Annastraße 41 • 45130 Essen
www.autosen.com • info@autosen.com
We behouden ons het recht voor om technische wijzigingen aan te brengen zonder voorafgaande kennisgeving. - 5-4-2025



Mechanische gegevens

Bouwworm	Zylindrisch met Gewinde
Schroefdraadmaat	M18x1
Totale lengte	60,5 mm
Materiaal behuizing	V4A (1.4404)
Materiaal actief oppervlak	Polyamid (PA) Epoxid-Glaskeramiek
Elektrische aansluiting	M12 4-Polig Kontakte vergoldet

Nauwkeurigheid

Hysterese	< 1%
Resolutie	3 mm
Max. afwijking van 90° hoek sensor/object	± 4 °
temperatuurcompensatie	Ja
Opmerking	Die angegebenen Werte werden nach einer Aufwärmzeit von mindestens 20 Minuten erreicht

Omgevingsvoorwaarden

Omgevingstemperatuur min.	-20°C
Omgevingstemperatuur max.	70°C
Beschermingsgraad	IP67

Meer informatie

MTTF	237Jahre
Funcitieweergave	gelb grün 2 x LED Teacheingang
Meegeleverd toebehoren	2 Befestigungsmuttern 2 Unterlegscheiben
Teachfunctie	Ja
EMC-test	DIN EN 61000-4-2 ESD DIN EN 61000-4-3 HF gestraht DIN EN 61000-4-4 Burst DIN EN 61000-4-6 HF leitungsgebunden DIN EN 55011: Klasse A
Test schokbestendigheid	DIN EN 60068-2-27
Test vermoeidheidsgedrag	DIN EN 60068-2-6 Fc
Goedkeuring	CE cULus

Bestel online bij
Telefonische bestelling
Bestelling per fax

www.autosen.com
+49 (0) 201/749 189 21
+49 (0) 201/749 189 22

autosen gmbh • Annastraße 41 • 45130 Essen
www.autosen.com • info@autosen.com
We behouden ons het recht voor om technische wijzigingen aan te brengen zonder voorafgaande kennisgeving. - 5-4-2025



Toebehoren: Befestigungswinkel

	AA903 Bevestigingshoek M18	Stukprijs: 3,33 €*
---	--------------------------------------	----------------------------

Toebehoren: Schallumlenkwinkel / Schallrohr

	AA963 Geluidsreflectiehoek klein voor ultrasone sensoren	Stukprijs: 24,80 €*
---	--	-----------------------------

	AA965 Geluidsbuis voor ultrasone sensoren	Stukprijs: 27,83 €*
---	---	-----------------------------

Toebehoren: Schaltverstärker / Auswertung

	AN001 Schakelverstärker éénkanaals	Stukprijs: 80,86 €*
---	--	-----------------------------

Toebehoren: M12/M12 Verbindungsleitung | 4-pol. | PUR | IP67

	AA209 Verbindingskabel M12/M12 4-polig PUR 2 m IP67	Stukprijs: 9,29 €*
---	---	----------------------------

	AA211 Verbindingskabel M12/M12 4-polig PUR 2 m IP67	Stukprijs: 10,71 €*
---	---	-----------------------------

	AA210 Verbindingskabel M12/M12 4-polig PUR 5 m IP67	Stukprijs: 12,44 €*
---	---	-----------------------------

	AA212 Verbindingskabel M12/M12 4-polig PUR 5 m IP67	Stukprijs: 13,22 €*
---	---	-----------------------------

Toebehoren: M12/M12 Verbindungsleitung | 4-pol. | PUR | IP69K

	AA206 Verbindingskabel M12/M12 4-polig PUR 10 m IP69K	Stukprijs: 25,20 €*
---	---	-----------------------------

	AA205 Verbindingskabel M12/M12 4-polig PUR 10 m IP69K	Stukprijs: 22,15 €*
---	---	-----------------------------

	AA204 Verbindingskabel M12/M12 4-polig PUR 5 m IP69K	Stukprijs: 20,65 €*
---	--	-----------------------------

	AA202 Verbindingskabel M12/M12 4-polig PUR 5 m IP69K	Stukprijs: 17,28 €*
---	--	-----------------------------

	AA203 Verbindingskabel M12/M12 4-polig PUR 2 m IP69K	Stukprijs: 17,48 €*
---	--	-----------------------------

	AA201 Verbindingskabel M12/M12 4-polig PUR 2 m IP69K	Stukprijs: 14,11 €*
---	--	-----------------------------

Toebehoren: M12 Sensorleiding | 4-pol. | PUR | IP67

	AA052 Sensorleiding M12 4-polig PUR 2 m IP67	Stukprijs: 6,07 €*
---	--	----------------------------

	AA054 Sensorleiding M12 4-polig PUR 2 m IP67	Stukprijs: 6,45 €*
---	--	----------------------------

	AA053 Sensorleiding M12 4-polig PUR 5 m IP67	Stukprijs: 8,15 €*
---	--	----------------------------

	AA055 Sensorleiding M12 4-polig PUR 5 m IP67	Stukprijs: 8,65 €*
---	--	----------------------------

Toebehoren: M12 Sensorleiding | 4-pol. | PVC | IP67

	AA042 Sensorleiding M12 4-polig PVC 10 m IP67	Stukprijs: 10,97 €*
---	---	-----------------------------

	AA039 Sensorleiding M12 4-polig PVC 10 m IP67	Stukprijs: 10,58 €*
---	---	-----------------------------

	AA041 Sensorleiding M12 4-polig PVC 5 m IP67	Stukprijs: 8,22 €*
---	--	----------------------------

	AA038 Sensorleiding M12 4-polig PVC 5 m IP67	Stukprijs: 7,80 €*
---	--	----------------------------

Bestel online bij
Telefonische bestelling
Bestelling per fax

www.autosen.com
+49 (0) 201/749 189 21
+49 (0) 201/749 189 22

autosen gmbh • Annastraße 41 • 45130 Essen
www.autosen.com • info@autosen.com
We behouden ons het recht voor om technische wijzigingen aan te brengen zonder voorafgaande kennisgeving. - 5-4-2025



**AA040**

Sensorleiding M12 4-polig PVC 2 m IP67

Stukprijs: 6,00 €* **AA037**

Sensorleiding M12 4-polig PVC 2 m IP67

Stukprijs: 5,97 €* **AA064**

Sensorleiding M12 4-polig PVC 2 m IP67

Stukprijs: 4,52 €* **AA066**

Sensorleiding M12 4-polig PVC 2 m IP67

Stukprijs: 4,83 €* **AA065**

Sensorleiding M12 4-polig PVC 5 m IP67

Stukprijs: 6,05 €* **AA067**

Sensorleiding M12 4-polig PVC 5 m IP67

Stukprijs: 6,43 €* **Toebehoren: M12 Sensorleiding | 4-pol. | PVC | IP69K****AA025**

Sensorleiding M12 4-polig PVC 25 m IP69K

Stukprijs: 23,59 €* **AA027**

Sensorleiding M12 4-polig PVC 10 m IP69K

Stukprijs: 17,04 €* **AA024**

Sensorleiding M12 4-polig PVC 10 m IP69K

Stukprijs: 15,12 €* **AA026**

Sensorleiding M12 4-polig PVC 5 m IP69K

Stukprijs: 14,35 €* **AA023**

Sensorleiding M12 4-polig PVC 5 m IP69K

Stukprijs: 12,31 €* **AA032**

Sensorleiding M12 4-polig PVC 2 m IP69K

Stukprijs: 12,72 €* **AA031**

Sensorleiding M12 4-polig PVC 2 m IP69K

Stukprijs: 12,04 €* **AA028**

Sensorleiding M12 4-polig PVC 25 m IP69K

Stukprijs: 26,04 €* **Toebehoren: M12 Sensorleiding | 4-pol. | PUR | IP69K****AA018**

Sensorleiding M12 4-polig PUR 10 m IP69K

Stukprijs: 15,55 €* **AA017**

Sensorleiding M12 4-polig PUR 10 m IP69K

Stukprijs: 13,44 €* **AA008**

Sensorleiding M12 4-polig PUR 5 m IP69K

Stukprijs: 12,84 €* **AA006**

Sensorleiding M12 4-polig PUR 5 m IP69K

Stukprijs: 10,92 €* **AA007**

Sensorleiding M12 4-polig PUR 2 m IP69K

Stukprijs: 11,23 €* **AA005**

Sensorleiding M12 4-polig PUR 2 m IP69K

Stukprijs: 9,36 €* **Toebehoren: M12 Steckverbinder | 4-pol. | Stecker****AA946**

Confectioneerbare stecker haaks M12

Stukprijs: 7,01 €* **AA921**

Confectioneerbare stecker M12

Stukprijs: 7,01 €* **AA961**

Confectioneerbare stecker haaks M12 IP69K

Stukprijs: 15,00 €* **AA959**

Confectioneerbare stecker recht M12 IP69K

Stukprijs: 15,00 €* **Toebehoren: M12 Steckverbinder | 4-pol. | Dose****AA947**

Confectioneerbare doos haaks M12

Stukprijs: 6,91 €* **AA939**

confectioneerbare doos M12

Stukprijs: 6,91 €*

Bestel online bij
Telefonische bestelling
Bestelling per fax

www.autosen.com
+49 (0) 201/749 189 21
+49 (0) 201/749 189 22

autosen gmbh • Annastraße 41 • 45130 Essen
www.autosen.com • info@autosen.com
We behouden ons het recht voor om technische wijzigingen aan te brengen zonder voorafgaande kennisgeving. - 5-4-2025





AA962
Confectioneerbare doos haaks
M12 IP69k

Stukprijs: 15,00 €*



AA960
Confectioneerbare doos recht
M12 IP69k

Stukprijs: 15,00 €*

Toebehoren: Passivverteiler



AA501
Passieve verdeler 4 x M12 5 m
PUR

Stukprijs: 40,56 €*



AA503
Passieve verdeler 4 x M12 10 m
PUR

Stukprijs: 54,43 €*



AA502
Passieve verdeler 8 x M12 5 m
PUR

Stukprijs: 56,65 €*



AA504
Passieve verdeler 8 x M12 10 m
PUR

Stukprijs: 74,03 €*

Toebehoren: PNP-NPN-Konverter



AA033
PNP-NPN-omvormer 5 m PUR
M12 BKout

Stukprijs: 12,84 €*



AA034
PNP-NPN-omvormer 5 m PUR
M12 WHout

Stukprijs: 12,84 €*

Toebehoren: Y-Verteiler



AA046
Y-verdeelkabel M12/2 x M12

Stukprijs: 18,67 €*



AA922
Y-verdeler M12/2 x M12

Stukprijs: 12,27 €*

**Bestel online bij
Telefonische bestelling
Bestelling per fax**

www.autosen.com
+49 (0) 201/749 189 21
+49 (0) 201/749 189 22

autosen gmbh • Annastraße 41 • 45130 Essen
www.autosen.com • info@autosen.com
We behouden ons het recht voor om technische wijzigingen aan te brengen zonder voorafgaande kennisgeving. - 5-4-2025

