

AI002 Inductive sensor

High Resistance Class IP67



↳ Normally open	⇒) 2 mm	Ø M8
------------------------	----------------	-------------

Order by 2 pm - Shipping on the same working day

26,80 € offline price 28,36 €

Incl. 5.5% online discount for online orders

- DC, 10 ... 36 V, normally open, PNP
- 5.5% online discount
- Protection rating IP67
- 5-year warranty
- With LED output status indication
- Fast delivery

www.autosens.com/AI002

Direct link to the article on autosens.com

In daily use - proven millions of times over. Products from autosens are under highest quality requirements regarding robustness, insensitivity and reliability. We offer 5 years warranty - with money-back guarantee!

Dimensional drawing

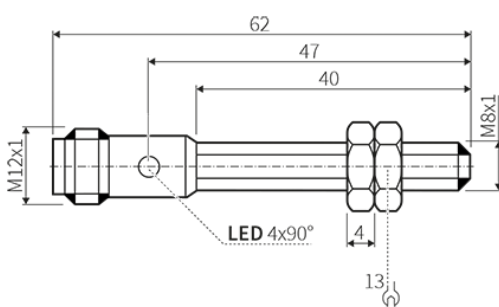

Connection & pin assignment

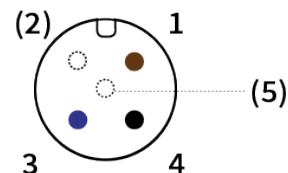
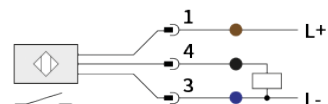

Order online at
Order by telephone
Order by fax

www.autosens.com
+49 (0) 201/749 189 21
+49 (0) 201/749 189 22

autosens gmbh • Annastraße 41 • 45130 Essen
www.autosens.com • info@autosens.com
 We reserve the right to make technical changes without notice - 1/26/2020



General information

Switching distance	2 mm
Switching frequency	800Hz

Outputs / inputs

Switching output	Normally open (NO)
------------------	--------------------

Electrical data

Operating voltage	10 ... 36 V DC supply class 2 cULus
Voltage type	Direct voltage (DC)
Electrical design	PNP
Current carrying capacity max.	200mA
Voltage drop max.	2.5V
Current consumption max.	15mA
Protection class	III
Short-circuit protection	Yes
Overload-proof	Yes
Reverse polarity protection	Yes

Mechanical data

Structural shape	Cylindrical with thread
Thread size	M8x1
Installation type	Flush
Structural length	62 mm
Material of housing	Brass coated with white bronze
Material of active surface	LCP
Electrical connection	M12 Contacts gold-plated 3-pin

Accuracy

Correction factors	St37 = 1 V2A approx. 0.7 Ms approx. 0.5 Al approx. 0.4 Cu approx. 0.3
--------------------	---



Ambient conditions

































Ambient temperature min.	-20°C
Ambient temperature max.	70°C
Protection rating	IP67

Additional information

MTTF	3419years
Function display	LED Visible all around Yellow
Accessories included with delivery	2 fastening nuts
EMC test	DIN EN 55011: Class B DIN EN 60947-5-2
Approval	CE cULus



Accessories: Connection technology

	AA037 Sensor cable 2 m Standard Class IP67	Unit price: 3,75 €* 		AA040 Sensor cable 2 m Standard Class IP67	Unit price: 4,27 €*
	AA038 Sensor cable 5 m Standard Class IP67	Unit price: 5,27 €* 		AA041 Sensor cable 5 m Standard Class IP67	Unit price: 5,56 €*
	AA005 Sensor cable 2 m PUR M12 4-pole IP69k	Unit price: 6,39 €* 		AA039 Sensor cable 10 m Standard Class IP67	Unit price: 7,50 €*
	AA006 Sensor cable 5 m PUR M12 4-pole IP69k	Unit price: 7,58 €* 		AA007 Sensor cable 2 m PUR M12 4-pole IP69k	Unit price: 7,75 €*
	AA042 Sensor cable 10 m Standard Class IP67	Unit price: 7,77 €* 		AA031 Sensor cable 2 m PVC M12 4-pole IP69k	Unit price: 8,38 €*
	AA008 Sensor cable 5 m PUR M12 4-pole IP69k	Unit price: 8,84 €* 		AA023 Sensor cable 5 m PVC M12 4-pole IP69k	Unit price: 8,98 €*
	AA032 Sensor cable 2 m PVC M12 4-pole IP69k	Unit price: 9,61 €* 		AA017 Sensor cable 10 m PUR M12 4-pole IP69k	Unit price: 10,28 €*
	AA026 Sensor cable 5 m PVC M12 4-pole IP69k	Unit price: 10,58 €* 		AA024 Sensor cable 10 m PVC M12 4-pole IP69k	Unit price: 10,83 €*
	AA201 Connection cable 2 m PUR M12/M12 IP69k	Unit price: 10,93 €* 		AA018 Sensor cable 10 m PUR M12 4-pole IP69k	Unit price: 11,63 €*
	AA027 Sensor cable 10 m PVC M12 4-pole IP69k	Unit price: 12,16 €* 		AA202 Connection cable 5 m PUR M12/M12 IP69k	Unit price: 13,54 €*
	AA203 Connection cable 2 m PUR M12/M12 IP69k	Unit price: 13,74 €* 		AA204 Connection cable 5 m PUR M12/M12 IP69k	Unit price: 15,66 €*
	AA205 Connection cable 10 m PUR M12/M12 IP69k	Unit price: 16,93 €* 		AA025 Sensor cable 25 m PVC M12 4-pole IP69k	Unit price: 16,98 €*
	AA028 Sensor cable 25 m PVC M12 4-pole IP69k	Unit price: 18,58 €* 		AA206 Connection cable 10 m PUR M12/M12 IP69k	Unit price: 19,50 €*
	AA947 Wirable socket angled M12	Unit price: 4,66 €* 		AA939 Wirable socket M12	Unit price: 4,73 €*
	AA960 Wirable socket angled M12 IP69k	Unit price: 11,68 €* 		AA962 Wirable socket angled M12 IP69k	Unit price: 11,68 €*
	AA033 PNP-NPN converter 5 m PUR M12 BKout	Unit price: 10,19 €* 		AA034 PNP-NPN converter 5 m PUR M12 WHout	Unit price: 10,19 €*

Order online at
Order by telephone
Order by fax

www.autosen.com
+49 (0) 201/749 189 21
+49 (0) 201/749 189 22

autosen gmbh • Annastraße 41 • 45130 Essen
www.autosen.com • info@autosen.com
We reserve the right to make technical changes without notice - 1/26/2020



**AA922**

Y distributor M12/2xM12

Unit price: 9,17 €***Accessories: Switched-mode power supplies/Pulse monitoring**

**AN001**

One-channel switching amplifier

Unit price: 65,28 €***AR003**

Speed monitor

Unit price: 115,55 €***Accessories: Mounting accessories**

**AA901**

M8 angle bracket

Unit price: 1,98 €*

Order online at
Order by telephone
Order by fax

www.autosen.com
+49 (0) 201/749 189 21
+49 (0) 201/749 189 22

autosen gmbh • Annastraße 41 • 45130 Essen
www.autosen.com • info@autosen.com
We reserve the right to make technical changes without notice - 1/26/2020

