



AB004 Signal lamp red - yellow - green with continuous/flashing light



 100 mm	 Continuous light / flashing	 M12
--	---	---

Order by 2 pm - Shipping on the same working day

59,69 € offline price
~~63,16 €~~

Incl. 5.5% online discount for online orders

In daily use - proven millions of times over. Products from autosens are under highest quality requirements regarding robustness, insensitivity and reliability. We offer 5 years warranty - with money-back guarantee!

- Easy to install
- 5.5% online discount
- Three colours (red, green, yellow)
- 5-year warranty
- Colour & flashing separately controllable
- Fast delivery

www.autosens.com/AB004

Direct link to the article on autosens.com

Dimensional drawing

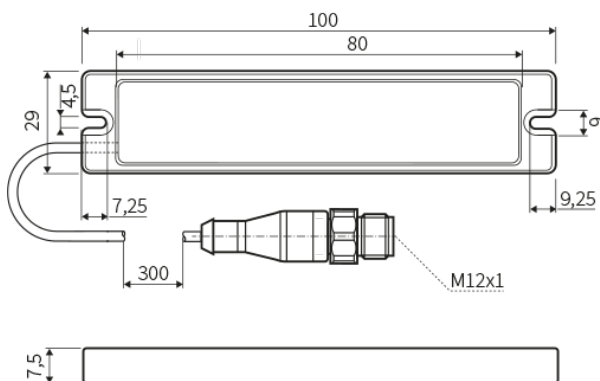

Connection & pin assignment

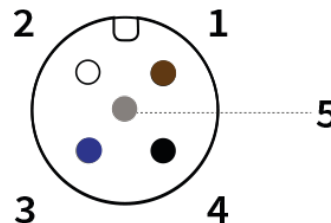

- 1 L+
- 2 IN2
- 3 GND
- 4 IN1
- 5 IN3



Wiring & pin configuration legend

IN1 -> Light color: red

IN2 -> Light color: yellow

IN2 -> Light color: yellow

IN3 -> flash

General information

Range of application	Optical display of machine states
Color temperature	Red, green, yellow

Outputs / inputs

Number of digital inputs	3: 2 digital inputs on pin 2 & 4 to control the colour / another input on pin 5 for the flashing function
IO-Link	No

Electrical data

Operating voltage	24 V DC \pm 10 %
Voltage type	Direct voltage (DC)
Power consumption at 24VDC	110 mA
Input power at 24VDC	2,7 W
Protection class	III
Reverse polarity protection	Yes

Mechanical data

Lighting area	80 mm x 25 mm
Structural length	100 mm
Material of housing	Aluminium anodised
Electrical connection	M12 With pigtail 5-pin
Cable length	0.3 m

Ambient conditions

Ambient temperature min.	-25°C
Ambient temperature max.	50°C
Shock / vibration	30g / 10-55Hz, 1mm
Protection rating	IP67

Additional information

Approval	CE
----------	----





















Order online at
Order by telephone
Order by fax

www.autosen.com
+49 (0) 201/749 189 21
+49 (0) 201/749 189 22

autosen gmbh • Annastraße 41 • 45130 Essen
www.autosen.com • info@autosen.com
We reserve the right to make technical changes without notice - 6/21/2021



Accessories: Connection technology

	AA037 Sensor cable 2 m Standard Class IP67	Unit price: 3,98 €* 		AA040 Sensor cable 2 m Standard Class IP67	Unit price: 4,53 €*
	AA038 Sensor cable 5 m Standard Class IP67	Unit price: 5,59 €* 		AA041 Sensor cable 5 m Standard Class IP67	Unit price: 5,90 €*
	AA005 Sensor cable 2 m PUR M12 4-pole IP69k	Unit price: 7,49 €* 		AA039 Sensor cable 10 m Standard Class IP67	Unit price: 7,95 €*
	AA042 Sensor cable 10 m Standard Class IP67	Unit price: 8,25 €* 		AA006 Sensor cable 5 m PUR M12 4-pole IP69k	Unit price: 8,82 €*
	AA031 Sensor cable 2 m PVC M12 4-pole IP69k	Unit price: 10,10 €* 		AA023 Sensor cable 5 m PVC M12 4-pole IP69k	Unit price: 10,32 €*
	AA017 Sensor cable 10 m PUR M12 4-pole IP69k	Unit price: 11,49 €* 		AA201 Connection cable 2 m PUR M12/M12 IP69k	Unit price: 12,00 €*
	AA024 Sensor cable 10 m PVC M12 4-pole IP69k	Unit price: 12,42 €* 		AA202 Connection cable 5 m PUR M12/M12 IP69k	Unit price: 14,76 €*
	AA205 Connection cable 10 m PUR M12/M12 IP69k	Unit price: 18,44 €* 		AA025 Sensor cable 25 m PVC M12 4-pole IP69k	Unit price: 19,46 €*
	AA947 Wirable socket angled M12	Unit price: 4,84 €* 		AA939 Wirable socket M12	Unit price: 4,91 €*
	AA960 Wirable socket angled M12 IP69k	Unit price: 12,54 €* 		AA962 Wirable socket angled M12 IP69k	Unit price: 12,54 €*
	AA922 Y distributor M12/2xM12	Unit price: 10,32 €* 			

Accessories: Mounting accessories

	AA969 Mounting kit	Unit price: 10,31 €*
---	------------------------------	------------------------------

Accessories: 5-pin connection technology

	AA043 Sensor cable 2m PUR M12 5-pole	Unit price: 8,40 €* 		AA044 Sensor cable 5m PUR M12 5-pole	Unit price: 10,56 €*
	AA045 Sensor cable 10m PUR M12 5-pole	Unit price: 14,34 €* 			

Order online at
Order by telephone
Order by fax

www.autosen.com
+49 (0) 201/749 189 21
+49 (0) 201/749 189 22

autosen gmbh • Annastraße 41 • 45130 Essen
www.autosen.com • info@autosen.com
We reserve the right to make technical changes without notice - 6/21/2021

