



# AI066 Inductive Factor-1-Sensor IP67

↶ Antivalent

➔ 20 mm

∅ Cubic

Order by 2 pm - Shipping on the same working day

**28,38 €** offline price 30,03 €

Incl. 5.5% online discount for online orders

- Active surface can be aligned in 5 pos.
- 5.5% online discount
- Correction factor = 1
- 5-year warranty
- Magnetic field resistant
- Fast delivery

[www.autosen.com/AI066](http://www.autosen.com/AI066)

Direct link to the article on autosen.com

In daily use - proven millions of times over. Products from autosen are under highest quality requirements regarding robustness, insensitivity and reliability. We offer 5 years warranty - with money-back guarantee!

## Dimensional drawing

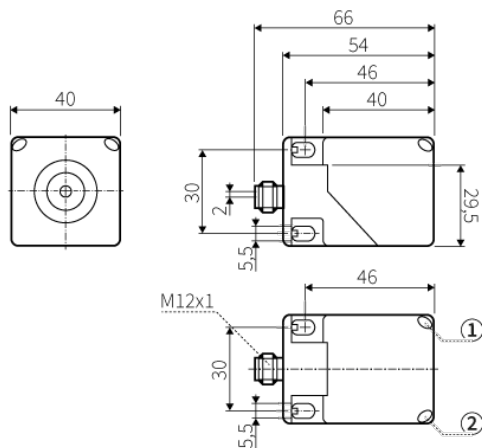

## Connection & pin assignment

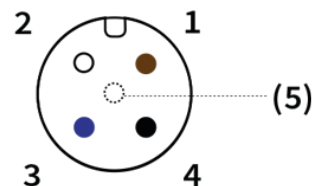
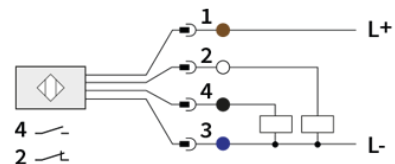

## Dimensional drawing legend

- 1: LED yellow
- 2: LED green

Order online at  
Order by telephone  
Order by fax

[www.autosen.com](http://www.autosen.com)  
**+49 (0) 201/749 189 21**  
**+49 (0) 201/749 189 22**

autosen gmbh • Annastraße 41 • 45130 Essen  
[www.autosen.com](http://www.autosen.com) • [info@autosen.com](mailto:info@autosen.com)  
We reserve the right to make technical changes without notice - 6/21/2021



## General information

---

Switching distance	20 mm
Switching frequency	200Hz

## Outputs / inputs

---

Switching output	Antivalent
IO-Link	No

## Electrical data

---

Operating voltage	10 ... 36V DC supply class 2 cULus
Voltage type	Direct voltage (DC)
Electrical design	PNP
Current carrying capacity max.	200mA
Voltage drop max.	2.5V
Current consumption max.	20mA
Protection class	II
Short-circuit protection	Yes
Overload-proof	Yes
Reverse polarity protection	Yes

## Mechanical data

---

Structural shape	Cuboid
Installation type	Flush
Structural length	66 mm
Material of housing	PA
Material of active surface	PA
Electrical connection	M12 4-pin Contacts gold-plated

## Accuracy

---

Correction factors	St37 = 1 V2A = 1 Ms = 1 Al = 1 Cu = 1
Hysteresis	1 ... 20 % of the real switching distance Sr



## Ambient conditions

---

Ambient temperature min.	-25°C
Ambient temperature max.	70°C
Magnetic field-resistant	Yes up to 300 mT
Protection rating	IP67

































## Additional information

---

MTTF	975years
Function display	Yellow Green 2 x LED
Accessories included with delivery	No accessories included
EMC test	DIN EN 55011: Class B DIN EN 61000-4-2 ESD DIN EN 61000-4-3 HF radiated DIN EN 61000-4-4 burst DIN EN 61000-4-5 surge DIN EN 61000-4-6 HF grid-bound
Approval	CE cULus



## Accessories: Connection technology

	<b>AA037</b> Sensor cable 2 m Standard Class IP67	<b>Unit price: 3,98 €* </b>		<b>AA040</b> Sensor cable 2 m Standard Class IP67	<b>Unit price: 4,53 €* </b>
	<b>AA038</b> Sensor cable 5 m Standard Class IP67	<b>Unit price: 5,59 €* </b>		<b>AA041</b> Sensor cable 5 m Standard Class IP67	<b>Unit price: 5,90 €* </b>
	<b>AA005</b> Sensor cable 2 m PUR M12 4-pole IP69k	<b>Unit price: 7,49 €* </b>		<b>AA039</b> Sensor cable 10 m Standard Class IP67	<b>Unit price: 7,95 €* </b>
	<b>AA042</b> Sensor cable 10 m Standard Class IP67	<b>Unit price: 8,25 €* </b>		<b>AA006</b> Sensor cable 5 m PUR M12 4-pole IP69k	<b>Unit price: 8,82 €* </b>
	<b>AA007</b> Sensor cable 2 m PUR M12 4-pole IP69k	<b>Unit price: 9,02 €* </b>		<b>AA031</b> Sensor cable 2 m PVC M12 4-pole IP69k	<b>Unit price: 10,10 €* </b>
	<b>AA008</b> Sensor cable 5 m PUR M12 4-pole IP69k	<b>Unit price: 10,28 €* </b>		<b>AA023</b> Sensor cable 5 m PVC M12 4-pole IP69k	<b>Unit price: 10,32 €* </b>
	<b>AA032</b> Sensor cable 2 m PVC M12 4-pole IP69k	<b>Unit price: 10,50 €* </b>		<b>AA017</b> Sensor cable 10 m PUR M12 4-pole IP69k	<b>Unit price: 11,49 €* </b>
	<b>AA201</b> Connection cable 2 m PUR M12/M12 IP69k	<b>Unit price: 12,00 €* </b>		<b>AA026</b> Sensor cable 5 m PVC M12 4-pole IP69k	<b>Unit price: 12,00 €* </b>
	<b>AA024</b> Sensor cable 10 m PVC M12 4-pole IP69k	<b>Unit price: 12,42 €* </b>		<b>AA018</b> Sensor cable 10 m PUR M12 4-pole IP69k	<b>Unit price: 12,98 €* </b>
	<b>AA027</b> Sensor cable 10 m PVC M12 4-pole IP69k	<b>Unit price: 13,95 €* </b>		<b>AA202</b> Connection cable 5 m PUR M12/M12 IP69k	<b>Unit price: 14,76 €* </b>
	<b>AA203</b> Connection cable 2 m PUR M12/M12 IP69k	<b>Unit price: 14,94 €* </b>		<b>AA204</b> Connection cable 5 m PUR M12/M12 IP69k	<b>Unit price: 17,64 €* </b>
	<b>AA205</b> Connection cable 10 m PUR M12/M12 IP69k	<b>Unit price: 18,44 €* </b>		<b>AA025</b> Sensor cable 25 m PVC M12 4-pole IP69k	<b>Unit price: 19,46 €* </b>
	<b>AA206</b> Connection cable 10 m PUR M12/M12 IP69k	<b>Unit price: 21,21 €* </b>		<b>AA028</b> Sensor cable 25 m PVC M12 4-pole IP69k	<b>Unit price: 21,27 €* </b>
	<b>AA947</b> Wirable socket angled M12	<b>Unit price: 4,84 €* </b>		<b>AA939</b> Wirable socket M12	<b>Unit price: 4,91 €* </b>
	<b>AA960</b> Wirable socket angled M12 IP69k	<b>Unit price: 12,54 €* </b>		<b>AA962</b> Wirable socket angled M12 IP69k	<b>Unit price: 12,54 €* </b>
	<b>AA033</b> PNP-NPN converter 5 m PUR M12 BKout	<b>Unit price: 10,74 €* </b>		<b>AA034</b> PNP-NPN converter 5 m PUR M12 WHout	<b>Unit price: 10,74 €* </b>

Order online at  
Order by telephone  
Order by fax

[www.autosen.com](http://www.autosen.com)  
+49 (0) 201/749 189 21  
+49 (0) 201/749 189 22

autosen gmbh • Annastraße 41 • 45130 Essen  
[www.autosen.com](http://www.autosen.com) • [info@autosen.com](mailto:info@autosen.com)  
We reserve the right to make technical changes without notice - 6/21/2021



**AA922**

Y distributor M12/2xM12

**Unit price: 10,32 €\*** **Accessories: Switched-mode power supplies/Pulse monitoring**

---

**AN001**

One-channel switching amplifier

**Unit price: 68,28 €\*** **AR003**

Speed monitor

**Unit price: 116,34 €\*** **Accessories: Mounting accessories**

---

**AA905**

Mounting plate

**Unit price: 6,42 €\*** 

**Order online at**  
**Order by telephone**  
**Order by fax**

[www.autosen.com](http://www.autosen.com)  
**+49 (0) 201/749 189 21**  
**+49 (0) 201/749 189 22**

autosen gmbh • Annastraße 41 • 45130 Essen  
[www.autosen.com](http://www.autosen.com) • [info@autosen.com](mailto:info@autosen.com)  
We reserve the right to make technical changes without notice - 6/21/2021

