

A0007 Photoelectric sensor with PA housing



Transmitter	→ 20 m	* Red light
--------------------	---------------	--------------------

Order by 2 pm - Shipping on the same working day

47,08 € offline price 49,82 €

Incl. 5.5% online discount for online orders

- Through beam sensor - transmitter
- 5.5% online discount
- Visible red light for easy adjustment
- 5-year warranty
- Protection rating IP67
- Fast delivery

www.autosen.com/A0007

Direct link to the article on autosen.com

In daily use - proven millions of times over. Products from autosen are under highest quality requirements regarding robustness, insensitivity and reliability. We offer 5 years warranty - with money-back guarantee!

Dimensional drawing

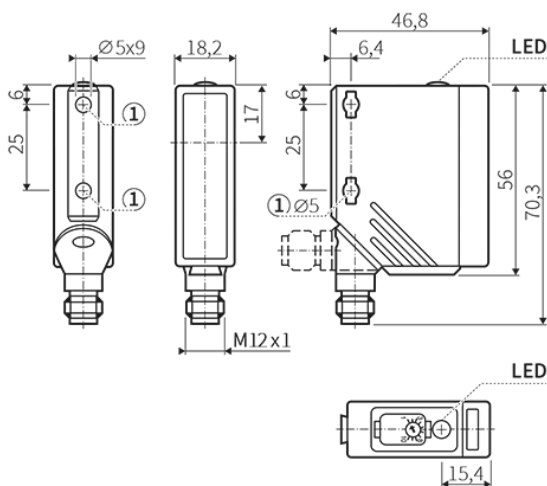

Function reserve bend

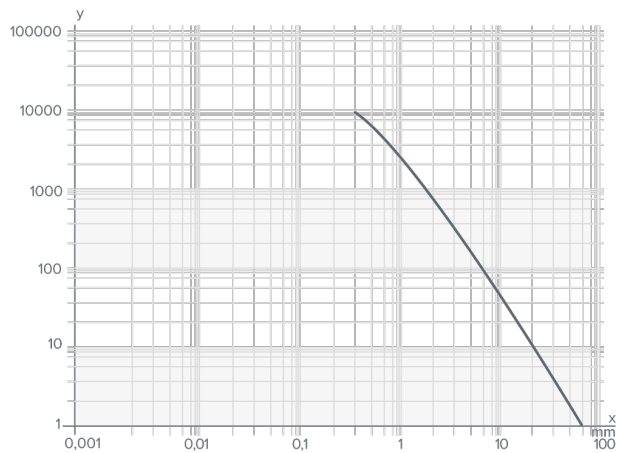

Dimensional drawing legend

the max. tightening torque is 2 Nm

1: When a M5 mounting screw is used, the max. tightening torque is 2 Nm, Receiver in upper lens, transmitter in lower lens

Order online at
Order by telephone
Order by fax

www.autosen.com
+49 (0) 201/749 189 21
+49 (0) 201/749 189 22

autosen gmbh • Annastraße 41 • 45130 Essen
www.autosen.com • info@autosen.com
 We reserve the right to make technical changes without notice - 10/20/2019



Function reserve bend legend

x - distance [mm]

y - excess gain factor

Connection & pin assignment

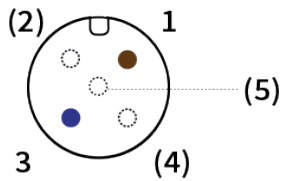
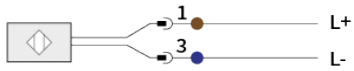

General information

Switching distance	20 m
Sensor type	Transmitter
Type of light	Red light

Outputs / inputs

IO-Link	No
---------	----

Electrical data

Operating voltage	10 ... 30 V DC supply class 2 cULus
Voltage type	Direct voltage (DC)
Electrical design	PNP
Current consumption max.	20mA
Protection class	II
Short-circuit protection	Yes
Overload-proof	Yes
Reverse polarity protection	Yes

Order online at
Order by telephone
Order by fax

www.autosen.com
+49 (0) 201/749 189 21
+49 (0) 201/749 189 22

autosen gmbh • Annastraße 41 • 45130 Essen
www.autosen.com • info@autosen.com
We reserve the right to make technical changes without notice - 10/20/2019



Mechanical data

Material of active surface	PMMA
Structural shape	Cuboid
Material of housing	Polyamide (PA) V4A
Electrical connection	TPE M12 Contacts gold-plated 2-pin

Accuracy

Light spot diameter	500 mm (with max. range)
---------------------	--------------------------

Ambient conditions





























Ambient temperature min.	-25°C
Ambient temperature max.	60°C
Protection rating	IP67

Additional information

MTTF	760years
Function display	Operation: LED, green
Accessories included with delivery	No accessories included
EMC test	DIN EN 60947-5-2
Approval	CE cULus



Accessories: Connection technology

	AA037 Sensor cable 2 m Standard Class IP67	Unit price: 3,75 €* 		AA040 Sensor cable 2 m Standard Class IP67	Unit price: 4,27 €*
	AA038 Sensor cable 5 m Standard Class IP67	Unit price: 5,27 €* 		AA041 Sensor cable 5 m Standard Class IP67	Unit price: 5,56 €*
	AA005 Sensor cable 2 m PUR M12 4-pole IP69k	Unit price: 6,39 €* 		AA039 Sensor cable 10 m Standard Class IP67	Unit price: 7,50 €*
	AA006 Sensor cable 5 m PUR M12 4-pole IP69k	Unit price: 7,58 €* 		AA007 Sensor cable 2 m PUR M12 4-pole IP69k	Unit price: 7,75 €*
	AA042 Sensor cable 10 m Standard Class IP67	Unit price: 7,77 €* 		AA031 Sensor cable 2 m PVC M12 4-pole IP69k	Unit price: 8,38 €*
	AA008 Sensor cable 5 m PUR M12 4-pole IP69k	Unit price: 8,84 €* 		AA023 Sensor cable 5 m PVC M12 4-pole IP69k	Unit price: 8,98 €*
	AA032 Sensor cable 2 m PVC M12 4-pole IP69k	Unit price: 9,61 €* 		AA017 Sensor cable 10 m PUR M12 4-pole IP69k	Unit price: 10,28 €*
	AA026 Sensor cable 5 m PVC M12 4-pole IP69k	Unit price: 10,58 €* 		AA024 Sensor cable 10 m PVC M12 4-pole IP69k	Unit price: 10,83 €*
	AA201 Connection cable 2 m PUR M12/M12 IP69k	Unit price: 10,93 €* 		AA018 Sensor cable 10 m PUR M12 4-pole IP69k	Unit price: 11,63 €*
	AA027 Sensor cable 10 m PVC M12 4-pole IP69k	Unit price: 12,16 €* 		AA202 Connection cable 5 m PUR M12/M12 IP69k	Unit price: 13,54 €*
	AA203 Connection cable 2 m PUR M12/M12 IP69k	Unit price: 13,74 €* 		AA204 Connection cable 5 m PUR M12/M12 IP69k	Unit price: 15,66 €*
	AA205 Connection cable 10 m PUR M12/M12 IP69k	Unit price: 16,93 €* 		AA025 Sensor cable 25 m PVC M12 4-pole IP69k	Unit price: 16,98 €*
	AA028 Sensor cable 25 m PVC M12 4-pole IP69k	Unit price: 18,58 €* 		AA206 Connection cable 10 m PUR M12/M12 IP69k	Unit price: 19,50 €*
	AA033 PNP-NPN converter 5 m PUR M12 BKout	Unit price: 10,19 €* 		AA034 PNP-NPN converter 5 m PUR M12 WHout	Unit price: 10,19 €*
	AA922 Y distributor M12/2xM12	Unit price: 9,17 €* 			

Accessories: Switched-mode power supplies/Pulse monitoring

Order online at
Order by telephone
Order by fax

www.autosen.com
+49 (0) 201/749 189 21
+49 (0) 201/749 189 22

autosen gmbh • Annastraße 41 • 45130 Essen
www.autosen.com • info@autosen.com
We reserve the right to make technical changes without notice - 10/20/2019



**AN001**

One-channel switching amplifier

Unit price: 65,28 €* **AR003**

Speed monitor

Unit price: 115,55 €*

Accessories: Mounting accessories

**AA906**

Angle bracket

Unit price: 6,37 €*

Accessories: Suitable sensors

**AO008**

Photoelectric sensor with PA housing

Unit price: 55,11 €*

Order online at
Order by telephone
Order by fax

www.autosen.com
+49 (0) 201/749 189 21
+49 (0) 201/749 189 22

autosen gmbh • Annastraße 41 • 45130 Essen
www.autosen.com • info@autosen.com
We reserve the right to make technical changes without notice - 10/20/2019

