



AI029 Inductive Factor-1-Sensor IP69k

↶ Normally open	➔ 10 mm	Ø M12
-----------------	---------	-------

Order by 2 pm - Shipping on the same working day

25,98 € offline price 27,49 €

Incl. 5.5% online discount for online orders

- Cannot be installed flush
- 5.5% online discount
- Correction factor = 1
- 5-year warranty
- Magnetic field resistant
- Fast delivery

www.autosen.com/AI029

Direct link to the article on autosen.com

In daily use - proven millions of times over. Products from autosen are under highest quality requirements regarding robustness, insensitivity and reliability. We offer 5 years warranty - with money-back guarantee!

Dimensional drawing

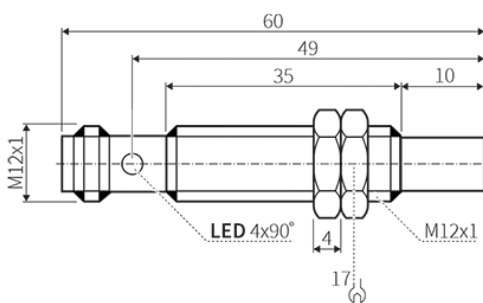

Connection & pin assignment

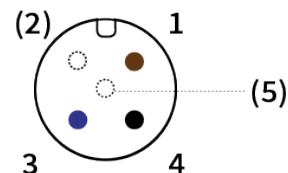
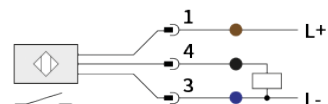

General information

Switching distance	10 mm
Switching frequency	2000Hz

Outputs / inputs

Switching output	Normally open (NO)
------------------	--------------------

Electrical data

Operating voltage	10 ... 30 V DC
Voltage type	Direct voltage (DC)
Electrical design	PNP
Current carrying capacity max.	100mA
Voltage drop max.	2.5V
Current consumption max.	20mA
Protection class	III
Short-circuit protection	Yes
Overload-proof	Yes
Reverse polarity protection	Yes

Mechanical data

Structural shape	Cylindrical with thread
Thread size	M12
Installation type	Not flush
Structural length	60 mm
Material of housing	Brass coated with white bronze
Material of active surface	LCP
Electrical connection	M12 3-pin Contacts gold-plated

Accuracy

Correction factors	St37 = 1 V2A = 1 Ms = 1 Al = 1 Cu = 1
Hysteresis	3 ... 15 % of the real switching distance Sr



Ambient conditions

Ambient temperature min.	-40°C
Ambient temperature max.	85°C
Magnetic field-resistant	Yes up to 300 mT
Protection rating	IP65
	IP66
	IP67
	IP68
	IP69k

Additional information

MTTF	474years
Function display	4 x LED
	Yellow
Accessories included with delivery	2 fastening nuts
EMC test	DIN EN 55011: Class B
	DIN EN 61000-4-2 ESD
	DIN EN 61000-4-3 HF radiated
	DIN EN 61000-4-4 burst
	DIN EN 61000-4-6 HF grid-bound
Shock resistance test	DIN EN 60068-2-27
Long-term shock resistance test	EN 60068-2-29 Eb
Salt spray test	EN 60068-2-52 Kb
Rapid temperature change test	EN 60068-2-14 Na
Vibration resistance test	DIN EN 60068-2-6 Fc
Approval	CE
	cULus

































Order online at
Order by telephone
Order by fax

www.autosen.com
+49 (0) 201/749 189 21
+49 (0) 201/749 189 22

autosen gmbh • Annastraße 41 • 45130 Essen
www.autosen.com • info@autosen.com
We reserve the right to make technical changes without notice - 4/4/2020



Accessories: Connection technology

	AA037 Sensor cable 2 m Standard Class IP67	Unit price: 3,83 €*		AA040 Sensor cable 2 m Standard Class IP67	Unit price: 4,36 €*
	AA038 Sensor cable 5 m Standard Class IP67	Unit price: 5,38 €*		AA041 Sensor cable 5 m Standard Class IP67	Unit price: 5,67 €*
	AA005 Sensor cable 2 m PUR M12 4-pole IP69k	Unit price: 6,97 €*		AA039 Sensor cable 10 m Standard Class IP67	Unit price: 7,65 €*
	AA042 Sensor cable 10 m Standard Class IP67	Unit price: 7,93 €*		AA006 Sensor cable 5 m PUR M12 4-pole IP69k	Unit price: 8,20 €*
	AA007 Sensor cable 2 m PUR M12 4-pole IP69k	Unit price: 8,38 €*		AA031 Sensor cable 2 m PVC M12 4-pole IP69k	Unit price: 9,39 €*
	AA008 Sensor cable 5 m PUR M12 4-pole IP69k	Unit price: 9,56 €*		AA023 Sensor cable 5 m PVC M12 4-pole IP69k	Unit price: 9,61 €*
	AA032 Sensor cable 2 m PVC M12 4-pole IP69k	Unit price: 10,02 €*		AA017 Sensor cable 10 m PUR M12 4-pole IP69k	Unit price: 10,69 €*
	AA026 Sensor cable 5 m PVC M12 4-pole IP69k	Unit price: 11,31 €*		AA201 Connection cable 2 m PUR M12/M12 IP69k	Unit price: 11,42 €*
	AA024 Sensor cable 10 m PVC M12 4-pole IP69k	Unit price: 11,55 €*		AA018 Sensor cable 10 m PUR M12 4-pole IP69k	Unit price: 12,08 €*
	AA027 Sensor cable 10 m PVC M12 4-pole IP69k	Unit price: 12,97 €*		AA202 Connection cable 5 m PUR M12/M12 IP69k	Unit price: 14,05 €*
	AA203 Connection cable 2 m PUR M12/M12 IP69k	Unit price: 14,24 €*		AA204 Connection cable 5 m PUR M12/M12 IP69k	Unit price: 16,48 €*
	AA025 Sensor cable 25 m PVC M12 4-pole IP69k	Unit price: 18,10 €*		AA205 Connection cable 10 m PUR M12/M12 IP69k	Unit price: 18,44 €*
	AA028 Sensor cable 25 m PVC M12 4-pole IP69k	Unit price: 19,79 €*		AA206 Connection cable 10 m PUR M12/M12 IP69k	Unit price: 21,21 €*
	AA947 Wirable socket angled M12	Unit price: 4,75 €*		AA939 Wirable socket M12	Unit price: 4,83 €*
	AA960 Wirable socket angled M12 IP69k	Unit price: 12,15 €*		AA962 Wirable socket angled M12 IP69k	Unit price: 12,15 €*
	AA033 PNP-NPN converter 5 m PUR M12 BKout	Unit price: 10,29 €*		AA034 PNP-NPN converter 5 m PUR M12 WHout	Unit price: 10,29 €*

Order online at
Order by telephone
Order by fax

www.autosen.com
+49 (0) 201/749 189 21
+49 (0) 201/749 189 22

autosen gmbh • Annastraße 41 • 45130 Essen
www.autosen.com • info@autosen.com
We reserve the right to make technical changes without notice - 4/4/2020



**AA922**

Y distributor M12/2xM12

Unit price: 10,17 €* **Accessories: Switched-mode power supplies/Pulse monitoring**

**AN001**

One-channel switching amplifier

Unit price: 66,60 €* **AR003**

Speed monitor

Unit price: 119,02 €* **Accessories: Mounting accessories**

**AA902**

M12 angle bracket

Unit price: 1,73 €*

Order online at
Order by telephone
Order by fax

www.autosen.com
+49 (0) 201/749 189 21
+49 (0) 201/749 189 22

autosen gmbh • Annastraße 41 • 45130 Essen
www.autosen.com • info@autosen.com
We reserve the right to make technical changes without notice - 4/4/2020

